

M 3 6 C O M B O

Application Guide



selux

M36 Combo

Expanding the Lighting Toolbox

Selux M36 Combo allows you to combine and arrange lighting to suit your spatial demands. M36 Combo layers lighting by allowing choices of slim, ambient linear lighting, louvers, and/or mini adjustable spotlights to create visual interest. This luminaire utilizes the same optics as our popular M36 family, and incorporating the LED mini spotlights, opens a wide range of possibilities. For indirect illumination, a Lambertian diffuse lens, widespread batwing optic, and asymmetric ceiling wash optic are available. Choose M36 Combo when you're in need of modularity, precision optics, and efficiency. Use for interior applications such as commercial and retail spaces, galleries, museums, schools, offices, and hospitality.

Product Specifications

Combo Linear



- Series:** C36 Combo Linear
- Mounting:** Recessed · Cable · Swivel Stem · Rigid Stem · Surface · Wall
- Light Engine:** Mid-power LEDs · 80+ CRI · 90+ CRI
- Output:** Up to 1,542lm/ft and 11.1W/ft · 147lm/W
- CCT:** 2700K · 3000K · 3500K · 4000K
Tunable White · RGBW · BIOS
- Construction:** Extruded 6063-T6 aluminum housing
- Direct Shielding:** LED Optimized Lens · Microprismatic Inlay LMO Symmetric · LMO 20° Wall Washer · LMO 5° Wall Grazer · LMO Batwing · Black Louver · White Louver · Blank Cover
- Indirect Shielding:** LED Optimized Lens · LMO Wide · Batwing · LMO Indirect Asymmetric
- Options:** Emergency Circuit Wiring · Remote Micro Inverter (consult factory) · Unlit Corners · Sensors · RAL finish (consult factory) · Non-standard configurations (consult factory)

Mini Spot



- Series:** C36 Mini Spotlight
Integrated within C36 Combo
- CRI:** COB LED · 90+ CRI
- Output:** Up to 338lm and 4W · 84lm/W
- CCT:** 2700K · 3000K · 3500K · 4000K
- Construction:** Extruded 6063-T6 aluminum housing
- Grouping:** Single · Double · Triple
- Optical Distributions:** 14° Spot · 27° Medium · 37° Flood
- Optical Accessories:** Snoot · Honeycomb Louver

Dimensions

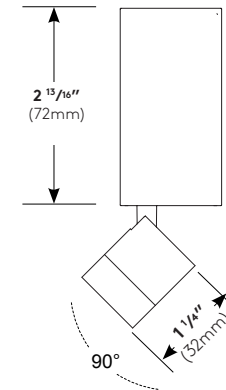
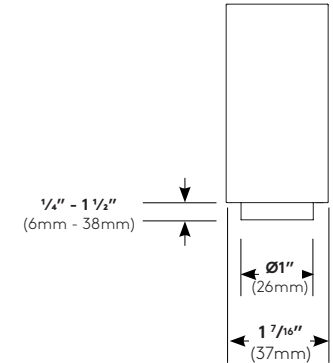

Offering a wide range of mounting options, For a variety of architectural applications

The M36 Combo is offered with a variety of mounting options, providing solutions for most architectural applications - including recessed, pendant, surface, and

wall mount. This luminaire is available as direct or direct/indirect. The indirect optical offerings are Lambertian diffuse lens, widespread batwing optic, and asymmetric ceiling wash optic.

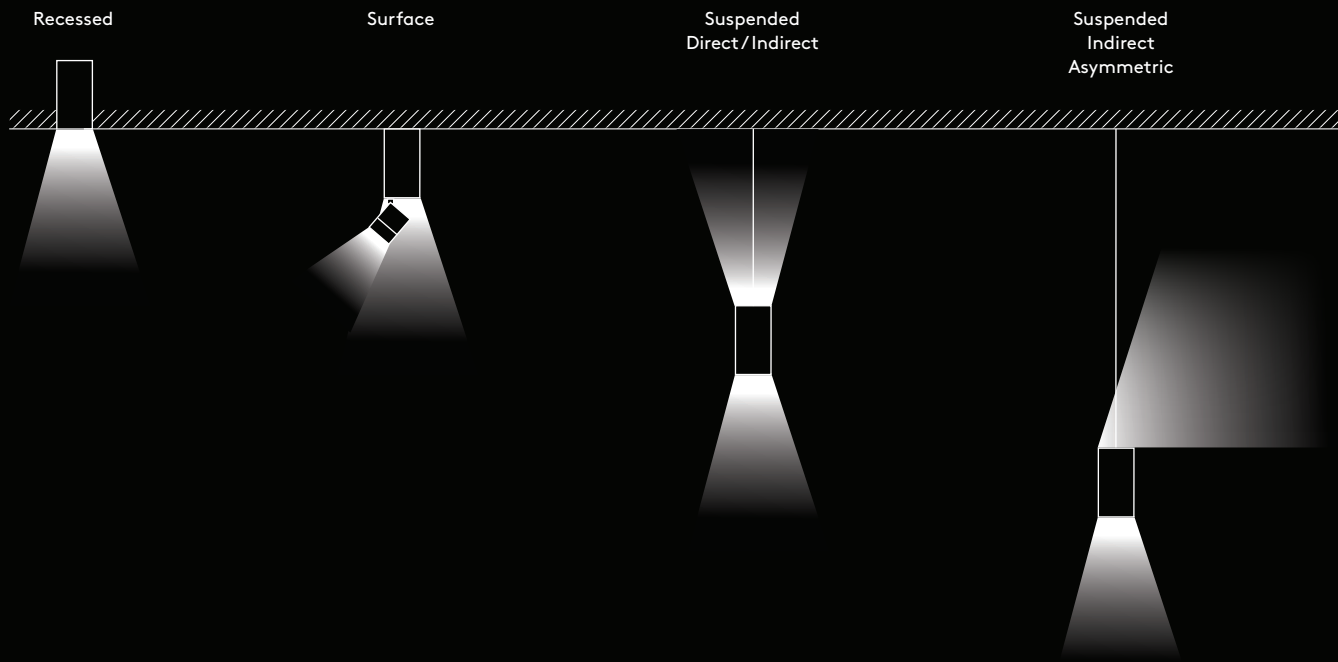

*Refer to individual fixture specification sheets for more information on mounting details and offerings

M36 Combo Louver



The highly efficient louver
provides **ambient lighting**
and **additional glare control**

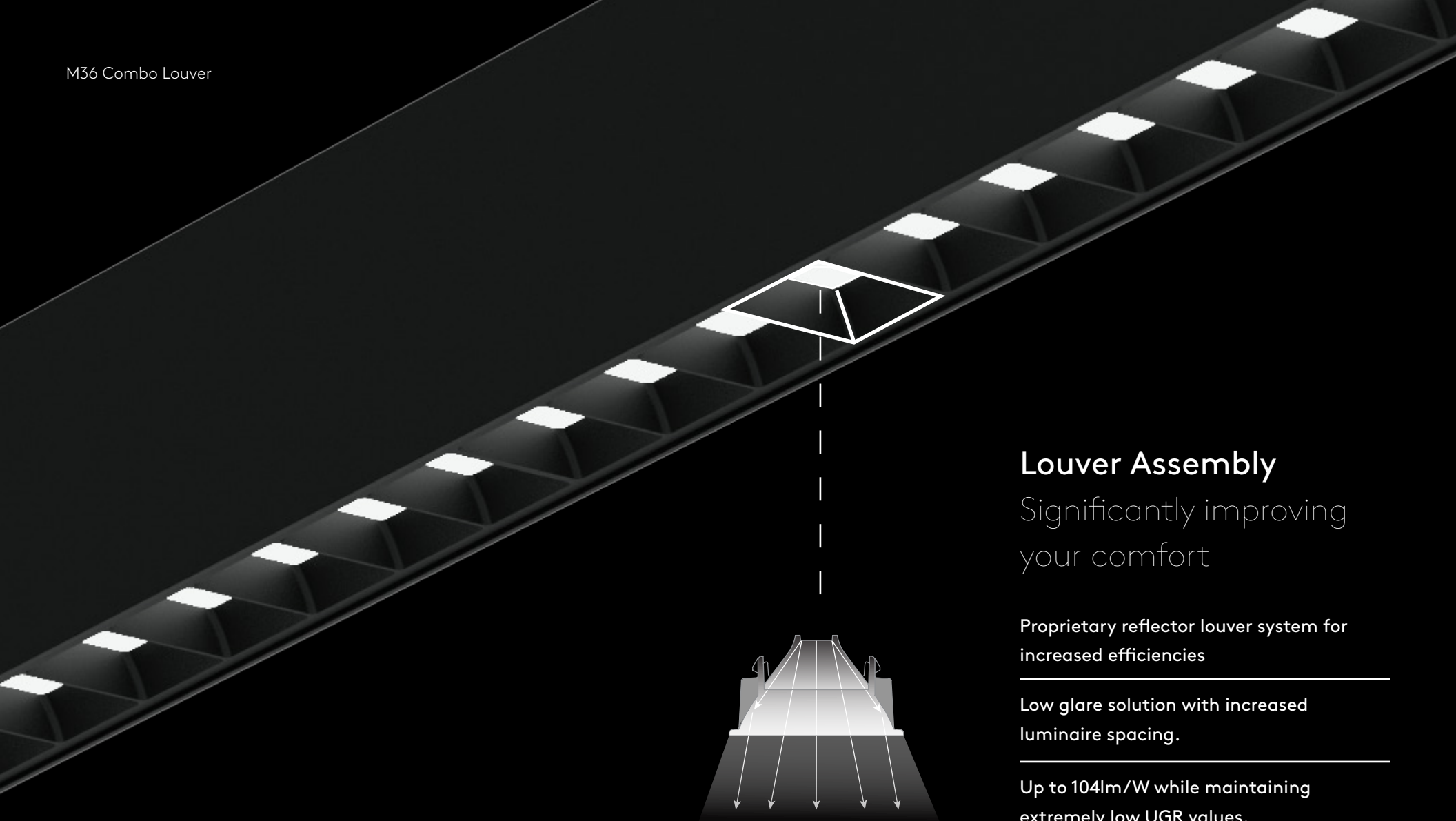

Louver Assembly

Significantly improving
your comfort

Proprietary reflector louver system for
increased efficiencies

Low glare solution with increased
luminaire spacing.

Up to 104lm/W while maintaining
extremely low UGR values.

Fixed



Adjustable

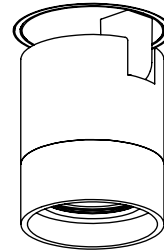

Pull down to
adjust and
point

Rotation

The mini spotlight can rotate max. 304° right to left. It can be inclined max. 90°, up and down.

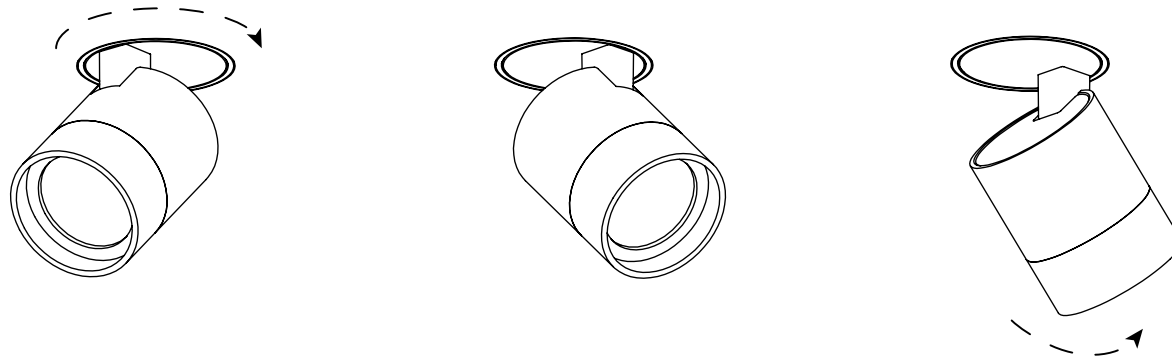

Groupings

Single

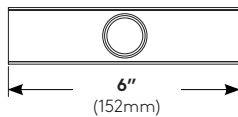

Double

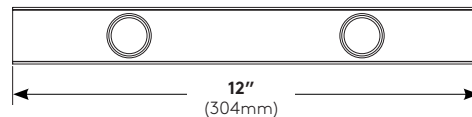

Triple

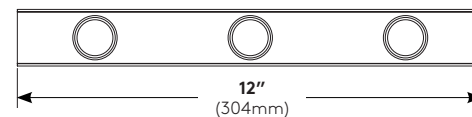

**Mini Spotlights provide
beauty and sparkle,**
adding an extra layer of light
to the environment

The mini spotlights have additional optical accessories available: an adjustable snoot or a hexagonal louver. These accessories reduce glare from the light source, providing visual comfort to the occupant.



Mini Spot
Optic



Hexagonal
Louver

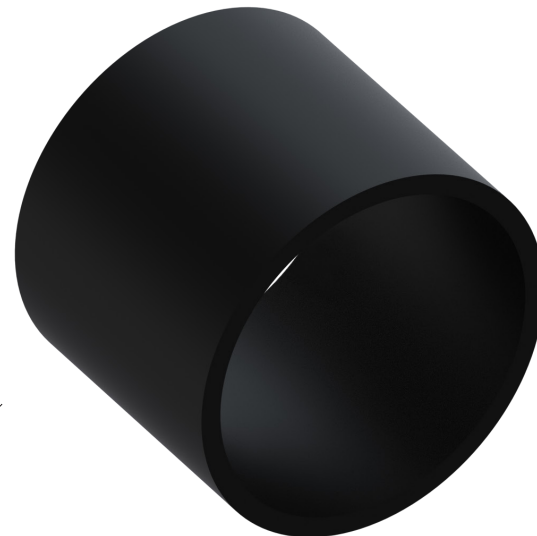

Snoot

Proprietary LED optical system

allows for impressionable lighting design

Our proprietary LED optical system - Light Modulation Optics (LMO) - have been integrated into the M36 Combo allowing for a more flexible lighting design throughout a space. The Combo luminaire offers a variety of shielding options including Lambertian optics, directional optics, and louvers.

M36 Combo Direct Shielding Options

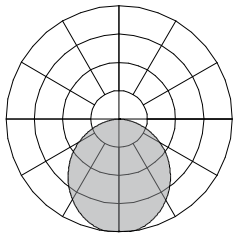

LW - LED Optimized White Lens
(up to 117lm/W)
Application: general illumination

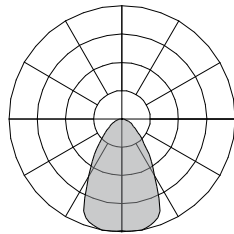

MI - Clear Lens with Microprism
(up to 120lm/W)
Application: low glare, focused task illumination

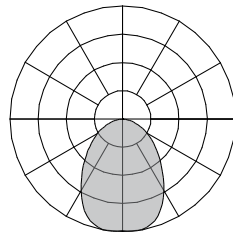

NB - LMO Symmetric
(up to 142lm/W)
Application: general task illumination

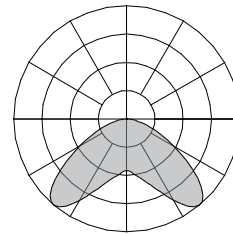

BW - LMO Batwing
(up to 129lm/W)
Application: general illumination, wide spacing

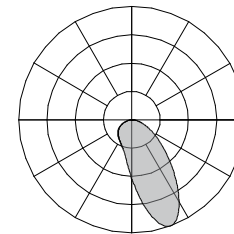

A2 - LMO Asymmetric 20° Wall Washer
(up to 147lm/W)
Application: wall washing

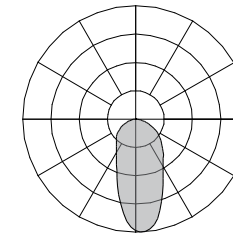

A5 - LMO Asymmetric 5° Wall Grazer
(up to 147lm/W)
Application: wall grazing

M36 Combo Indirect Shielding Options

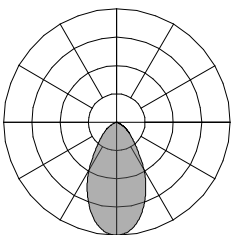

BM - Black Louver
(up to 83lm/W)
Application: low glare general illumination

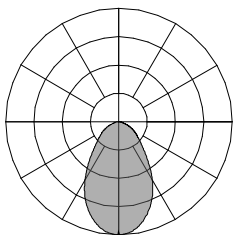

WM - White Louver
(up to 104lm/W)
Application: low glare general illumination

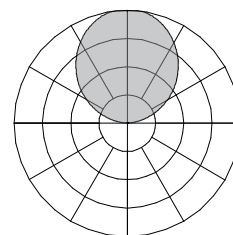

LW - LED Optimized White Lens
(up to 117lm/W)
Application: general illumination

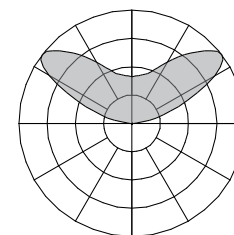

WB - LMO Wide Batwing
(up to 139lm/W)
Application: indirect wide spacing

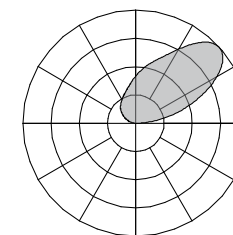

IA - Indirect Asymmetric
(up to 112lm/W)
Application: ceiling wash

Instilling vibrance into your environment

Color rendering is an important aspect of evaluating the quality of lighting. Generally, the higher the CRI, the more vibrant the color. However, CRI has its limitations, especially when it comes to accurately representing the full spectrum of colors that our eyes perceive. This is where TM-30 comes into play.

TM-30 is another method used for quantifying color rendering properties of light sources. It distinguishes both color fidelity and color gamut, providing a framework for interpreting chroma and hue shift associated with light sources. It gives the most valuable information on specific color enhancements. This graph shows how, on average, various colors are distorted. Outward arrows mean more saturated colors; inward arrows mean duller colors; sideways arrows mean a hue shift; and no arrow means that the color isn't distorted.

CRI 90



CRI 80



CRI 50-70

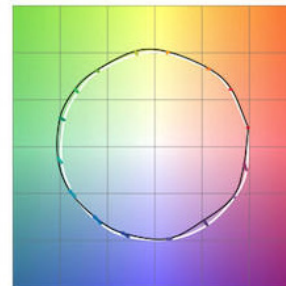

TM-30 Data
Mini Spotlight

TM-30 Rf	TM-30 Rg	CRI Ra	CRI R9
90	97	92	58

Bringing excitement to any project

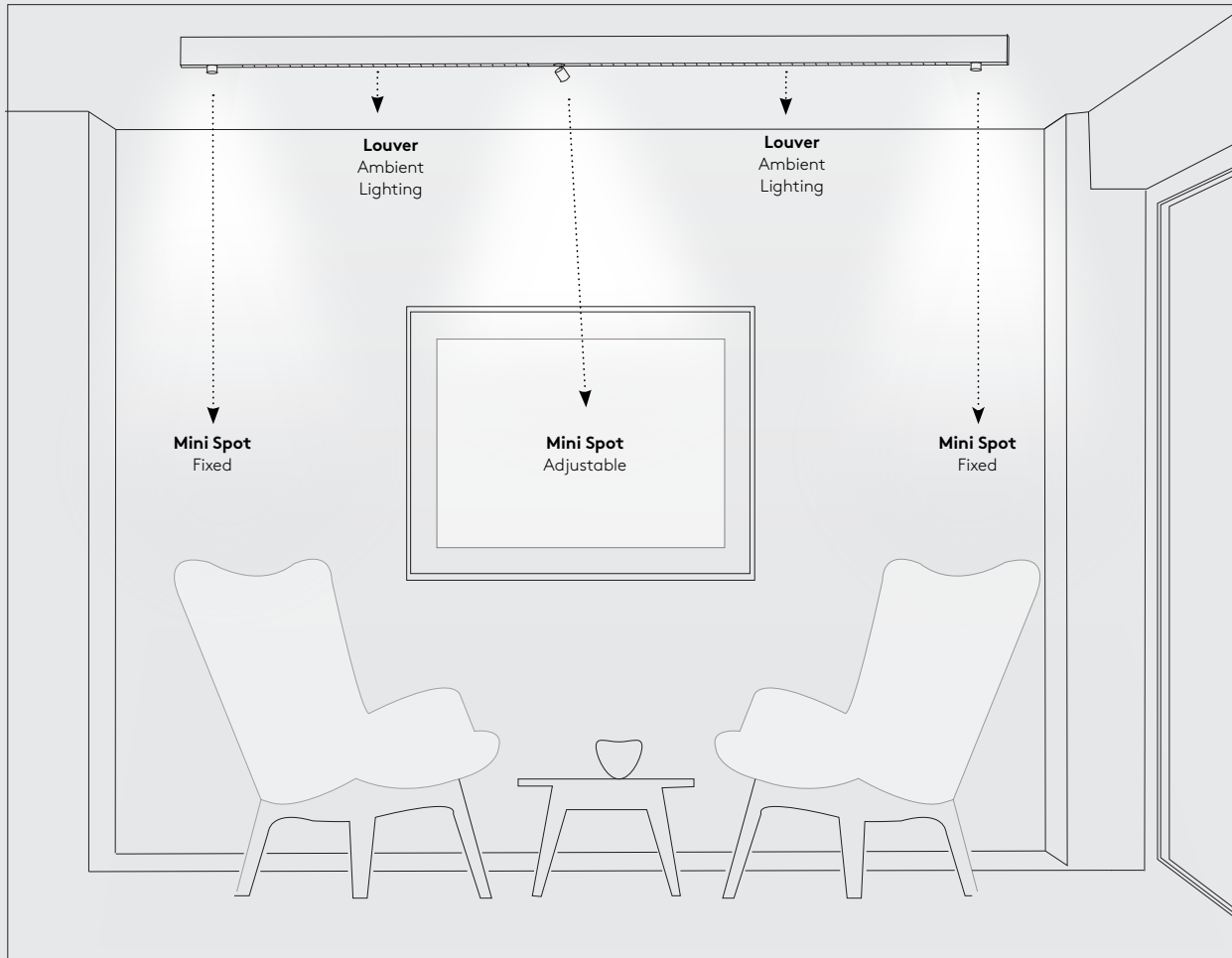

The slim M36 Combo can bring excitement to any project. This luminaire utilizes the same LMO optics for our current M36 family and can be configured in 6" increments (consult factory for exact lengths). The mini spotlights can be arranged in sections where accent lighting is needed to highlight elements. Use a choice of single, double, or triple mini spots together in one section, or spaced out along your luminaire - with the ability to aim the spotlight where you want. This miniature spot can be easily rotated where you need or left semi-recessed in the fixed position - making this mini spot discreet and flexible for any lighting application.

>
**HELLO
WORLD**
<





Indirect Asymmetric

Illuminating the room but
focusing in one direction

Indirect Asymmetric is ideal for concentrating the light beam up and in one main direction. It can minimize shadow and make a space feel larger. This is perfect for facilitating the transition from dark to light spaces, creating a comfortable atmosphere. Use the Indirect Asymmetric in offices, hospitality, galleries, airports, or when you need to portray a larger space or highlight a specific area above.



Configurations

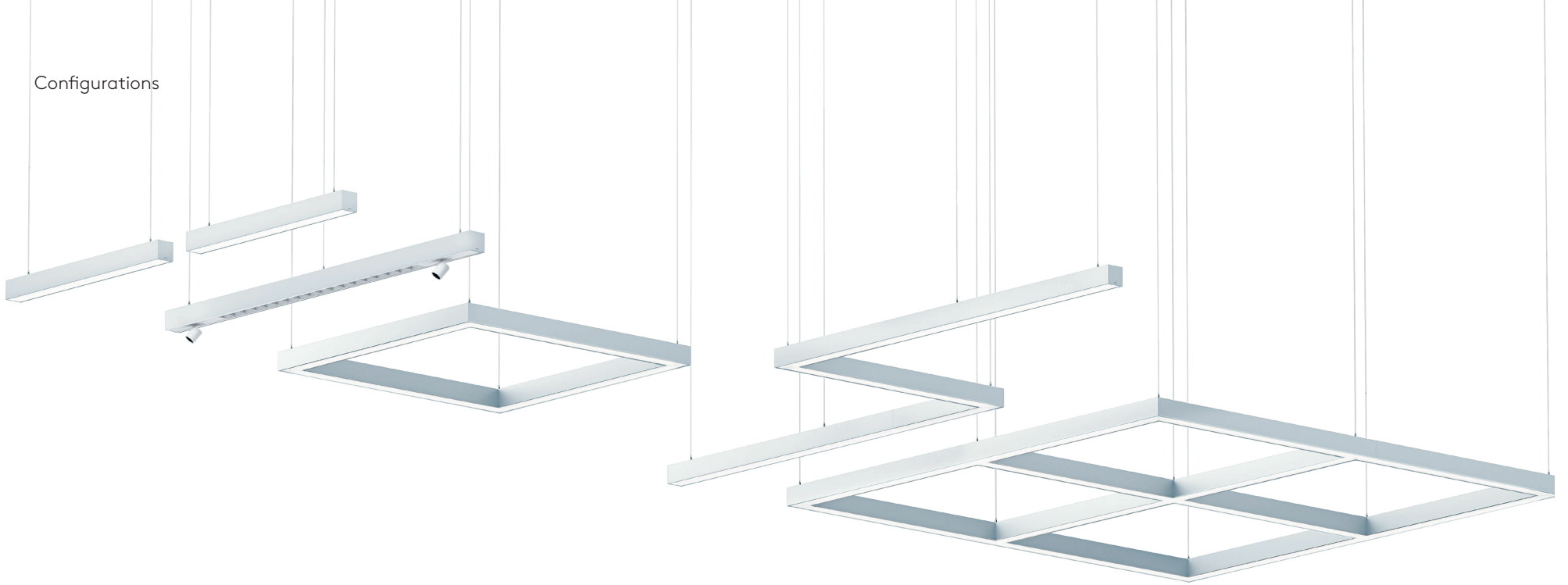

A Family of Flexibility

Freedom to Design

The M36 Combo offers design flexibility with unlit L, T, and X sections. Configure and use lighting concepts that align with your architectural layouts. Combine with the standard M36 for even more freedom and customization. For a visually larger space, incorporate indirect lighting into the M36 Combo to reduce shadows and balance the overall ambient lighting in the spatial environment. A various amount of dimming options and sensors lets you allow for greater control with these new lighting opportunities.

— THE —
COFFEE HOUSE

	2.5
	2.5
O	3
NO	3.5
	4
	5
URED COFFEE	5
	3.5



Selux Housing, Louver, and Mini Spots Finishes

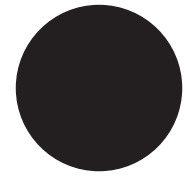
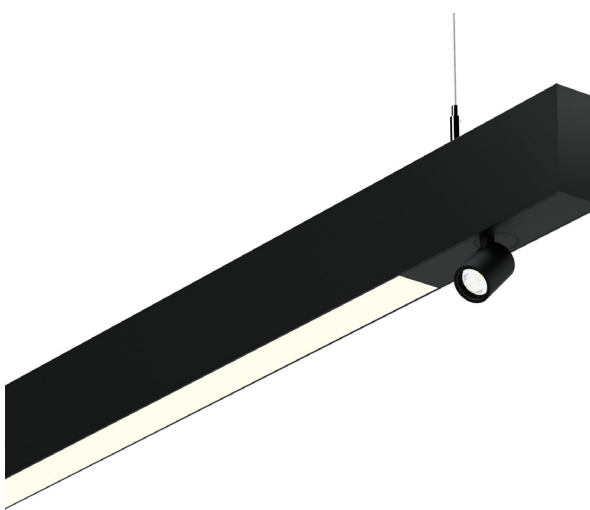
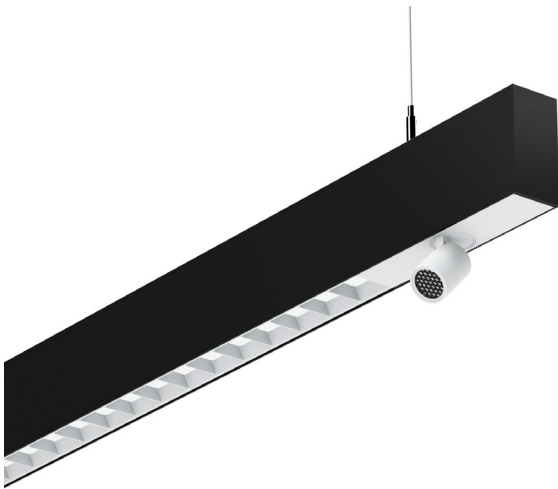
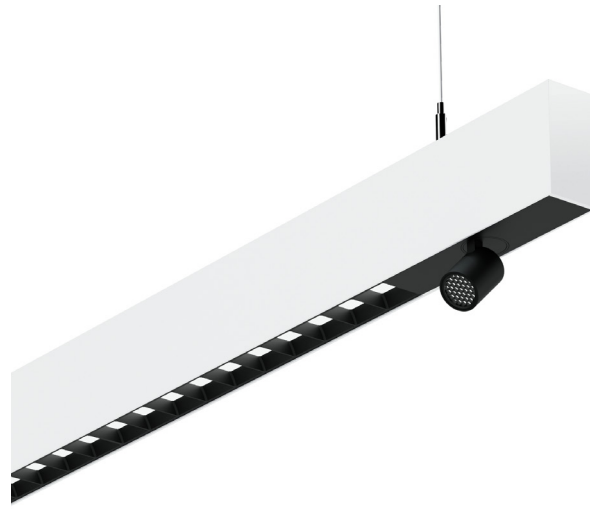
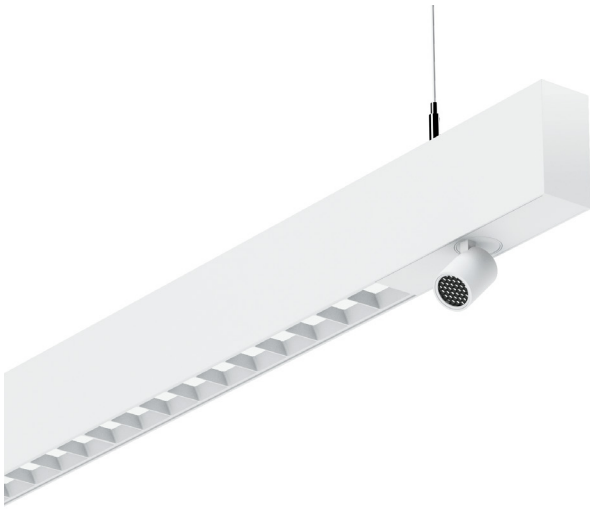

semi-matte
black finish

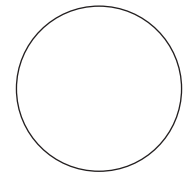

white
finish

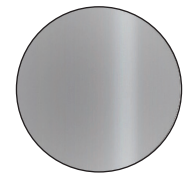

silver
finish



custom premium
finish

**Standard
Housing Finishes**
semi-matte black
custom premium
white
silver

**Standard
Mini Spotlight /
Louver Finishes**
black
white

Declare.  ®

M36 Combo

Declare label for an Interior luminaire

Declare is a platform to share and find healthy building products. Manufacturers willingly disclose product information that can be found on the Declare labels. These labels are then accessible on a free and searchable database used by prominent designers, real estate owners and home owners, to specify products they know they can trust and that meet the requirements of leading green building standards, including Core Green Building, LBC, LEED, and WELL Certification.

Declare has positively changed the materials marketplace to enable the creation of buildings that support human and environmental health and has made it extremely easy to facilitate and simplify the exchange of information.

Selux is also proud to be Living Future Corporate Member. With this credential, Selux is recognized for its proficiency in the world's more ambitious, advanced, and holistic sustainable design standards.

You can trust that with these credentials, Selux and Arca Pro, is a brand to trust.



LIVING FUTURE
CORPORATE MEMBER

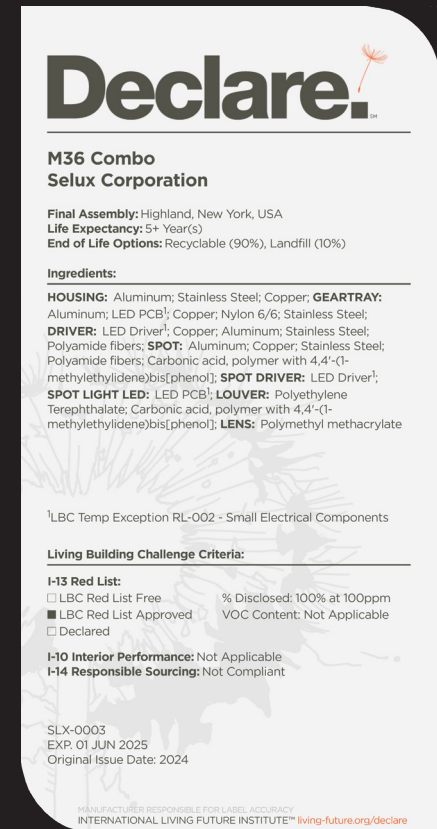

Publisher

Selux Corporation
5 Lumen Lane
Highland, NY 12528
www.selux.us

Edited by (responsible)

Selux Corporation

Concept and Design

Selux Corporation
www.selux.us

Print

Selux Corporation
5 Lumen Lane
Highland, NY 12528

Selux is a registered trademark of the Selux Corporation.
Errors accepted and subject to change due
to technical modifications. For conditions of sale
and delivery please refer to www.selux.us.

The use of the text and images, even in part, is
in breach of copyright without the consent of
the Selux Corporation and punishable. This also applies to
copies, translations, microfilming and processing
with electronic systems.

06/2024

